

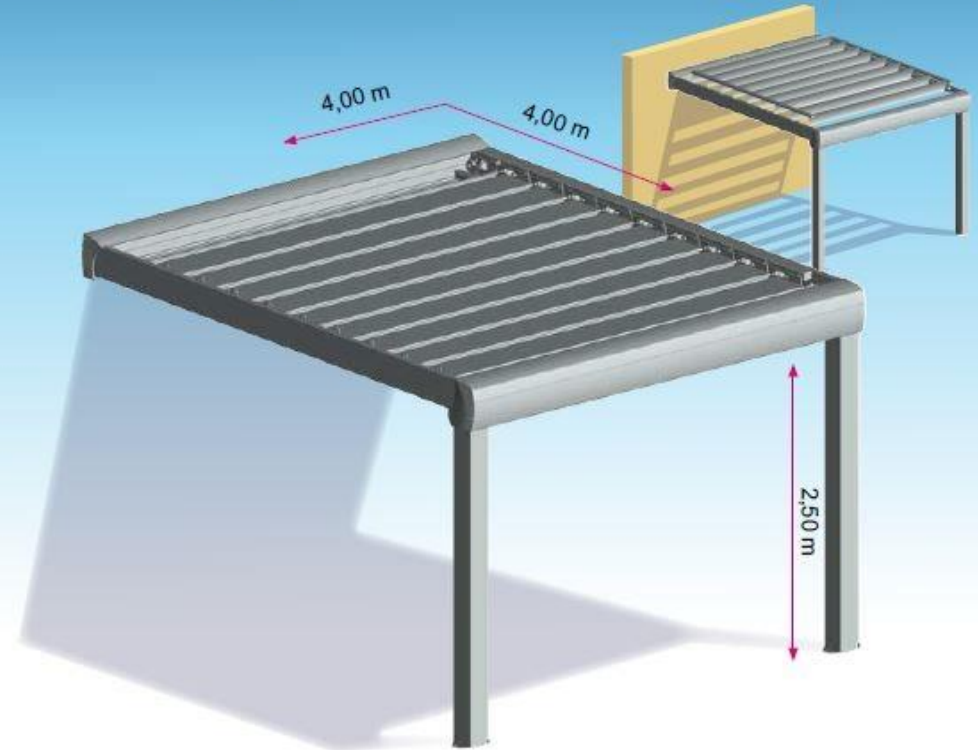

BRISE SOLEIL L

Motorline[®]
PROFESSIONAL



BRISE SOLEIL L

WEITERE DETAILS

- Design & Ästhetik
- Lamellen, Profile und Balken aus Aluminium
- Neigung der Lamellen
- Regulierung der teilweise oder vollen Sonneneinstrahlung
- Geschützt vor Regen
- Rinnensystem





In geschlossener Position gegen regen und Sonne
Fugenabdichtung



Vollkommen Sonnengeschützt
Maximal geschützt



Natürliche Lüftung
Multifunktional Schutz vor Sonneneinstrahlung und Natürliche Lüftung

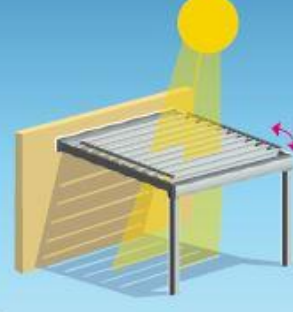

Sonnenstrahlen Ausrichtung
Einstellen des Lichtstroms der Sonnenstrahlung



Rotation der Lamellen
von 0° bis 90°

Neigung des Gehäuses
von 5° bis 25°

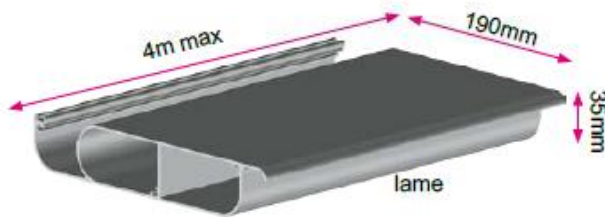
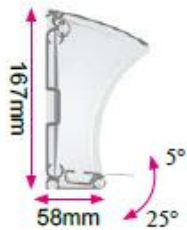
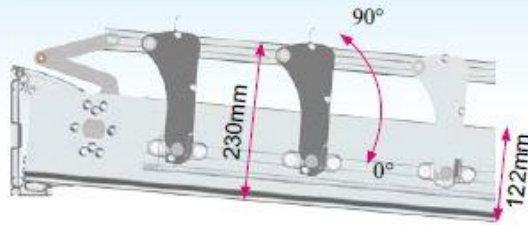

Fixierung

- Wandmontage des Gehäuses für eine bessere Festigkeit
- Schnelle und einfache Montage
- Bodenmontage
- Montage der Lamellen durch Clip System



Boden Platte zur Befestigung

Betrieb

- Bedienung mit Schalter

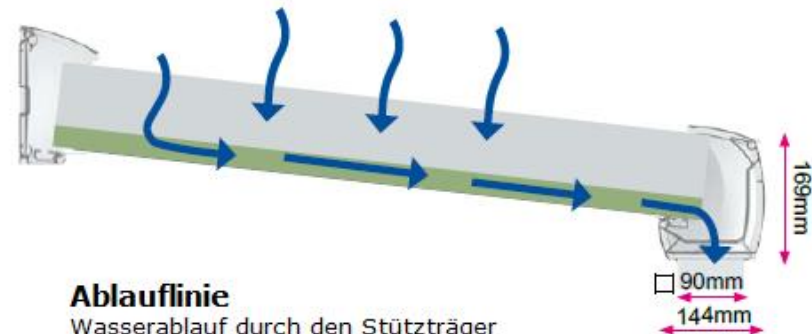

Ablauflinie

Wasserablauf durch den Stützträger

Standardausführung



RAL 7016 ANTHRACITE
Teflon Beschichtung



RAL 9010
Brilliant Laquierung

Mix



Amature



Lamelle

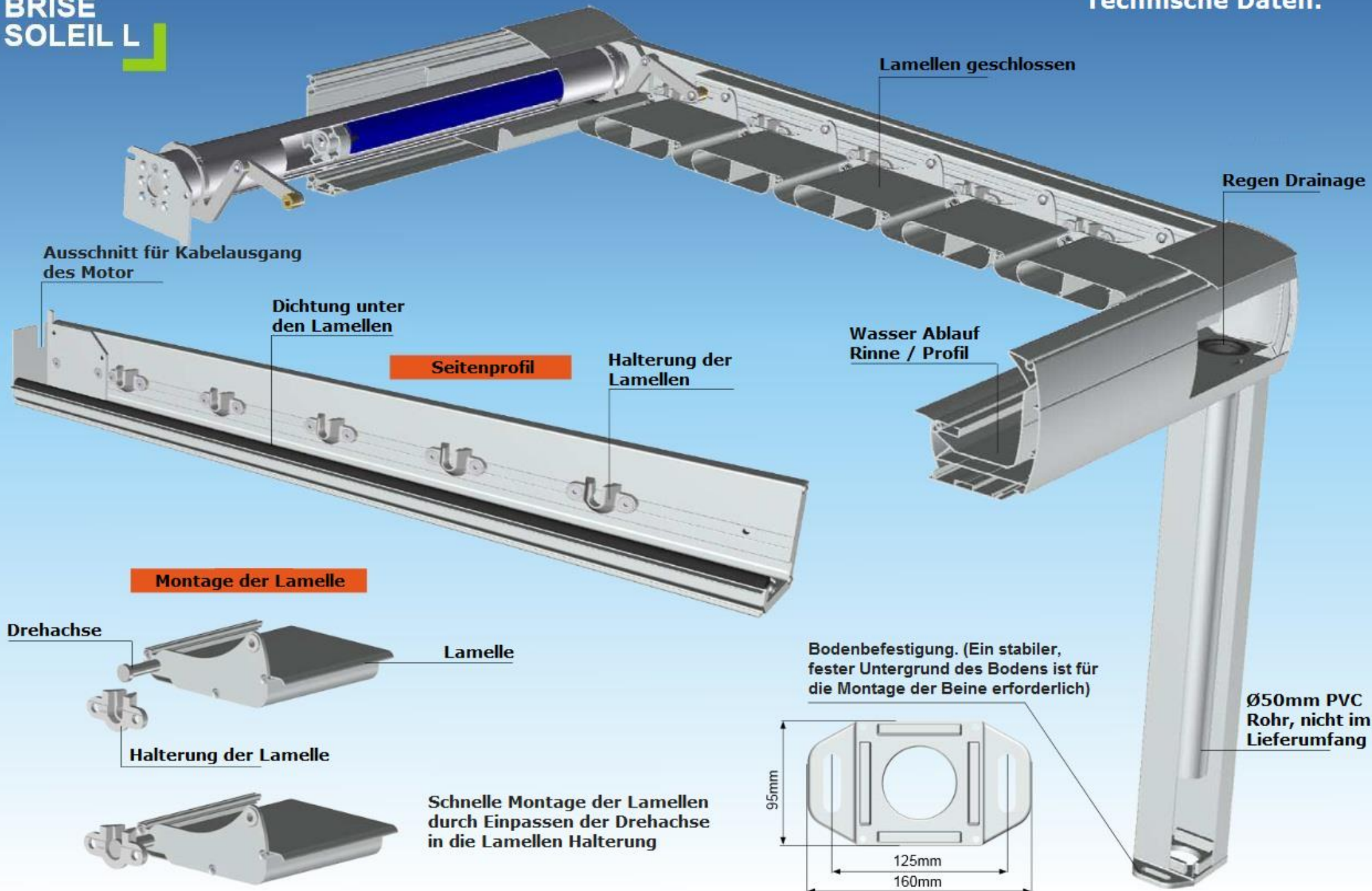

BRISE SOLEIL L

Manövrieren des Motor

Seitliches Lamellen Außenprofil

Orientierung der Lamellen 90°

Motor Serie GM100
Mini-Stromverbrauch 100N

Betätigungs Arm

Tuchwelle Ø78 125GP immer lackiert

Profil für Schwenkwinkel
der Pergola von 5° bis 25°

Unteres Endprofil der Ablauf Rinne

In Kürze:

Brise Soleil L Double
Breite 7.00m
Ausfall 4.00m
2 Motoren GM100
3 Fuß



Brise Soleil L Ilôt
Breite 4,00m
Ausfall 4.00m
1 Motor GM100
4 Füße

2 Lamellen Modelle



Max. breite 3,00m Lamelle PBS04302

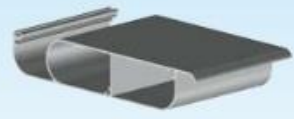

Breite zwischen 3,00m und 4,00m
Lamelle PBS043

Oberfläche:
Lastwiderstand, 45kg / m² - ist: 720kg / 16m²